

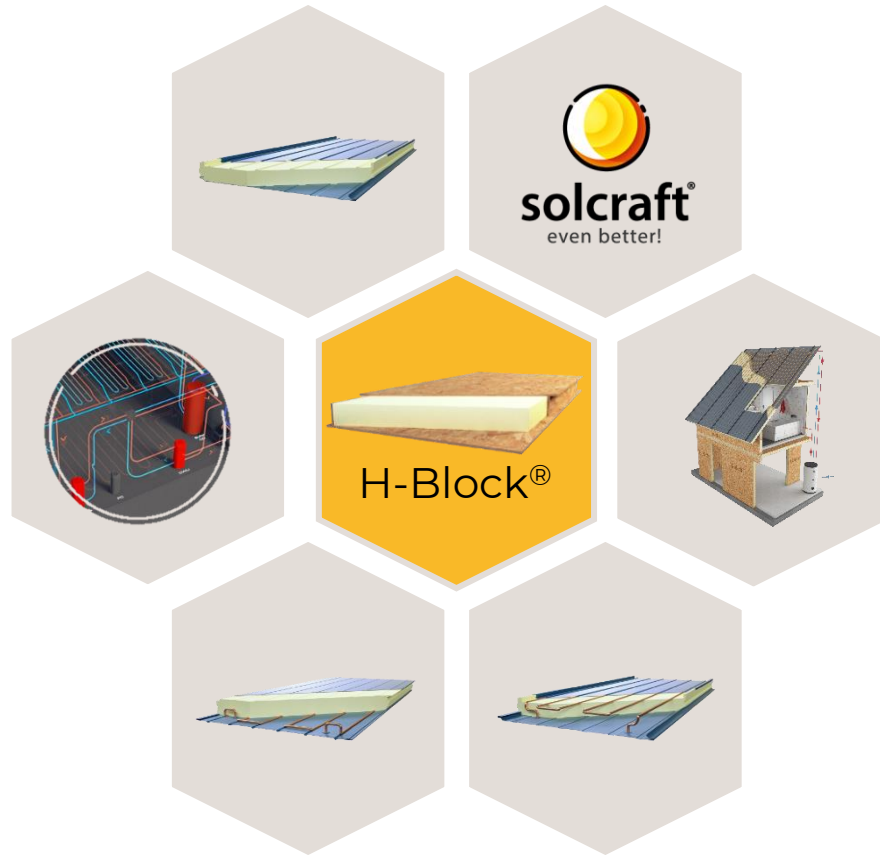

solcraft[®]
even better!

ENERGY EFFICIENT BUILDING SYSTEMS

PRODUCTS



What is H-BLOCK®

H-BLOCK® is:

- a patented, box shaped **variation of structural insulated panel (SIP)** made of polyurethane foam permanently combined with wood-based OSB panel;
- both **load-bearing** and **insulating** material;
- a construction material to build **load-bearing walls, ceilings, floors** and **roofs**;
- a construction material dedicated to the creation of energy efficient and passive buildings.

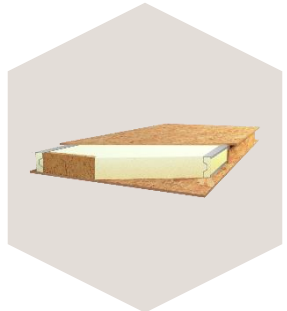
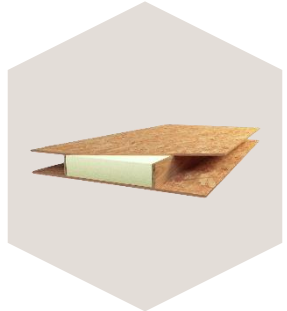
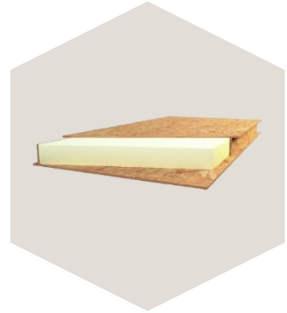
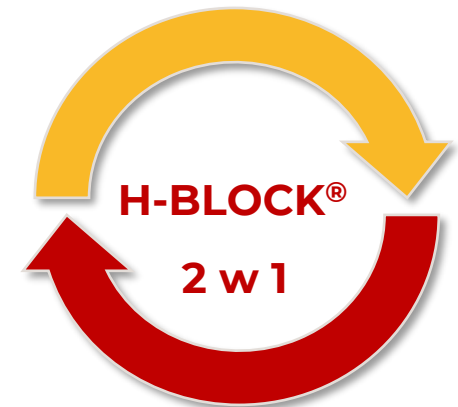

H-BLOCK[®] panel types

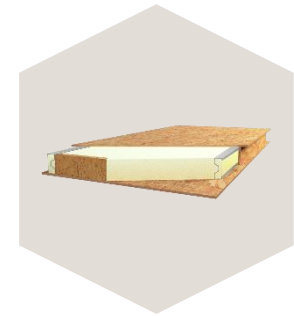
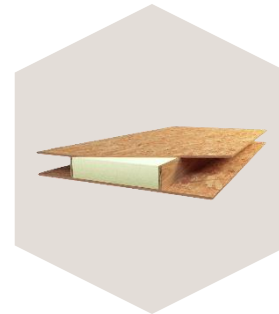
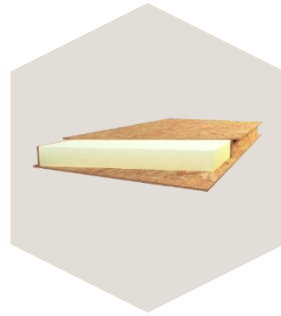

H-Block[®]

H-Block_{plus}[®]

H-Block_{sigma}[®]

	H-Block[®]	H-Block_{plus}[®]	H-Block_{sigma}[®]
Width	between 0,35 m and 1,25 m	1,25 m	between 0,625 m and 1,25 m
Length	up to 12,5 m	up to 12,5 m	up to 12,5 m
Total panel thickness	13 cm; 17 cm; 23 cm	13 cm; 17 cm; 23 cm	13 cm; 17 cm; 23 cm
Web type	OSB 3 15 mm	plywood 18 mm	sigma profile
Application	floors, walls, ceilings, roof	floors, ceilings, roof	floors, ceilings, roof
Joint type	LHB or KVH timber	LHB _{plus}	LHB
Joint width	12 – 28 cm	62,3 cm	12 – 28 cm



Panel thickness and thermal parameters

H-Block[®] / H-Block_{plus}[®] / H-Block_{sigma}[®] panels are produced in the following PU core thicknesses:

Heat transfer coefficient of the panel (declared) - U [W/m ² K]	PU core thickness [mm]
U=0,21	100
U=0,15	140
U=0,10	200



The following facing thickness should be added to the total thickness of the panel:

H-Block[®] / H-Block_{plus}[®] / H-Block_{sigma}[®]:

15 mm OSB + PU + 15 mm OSB

e.g. H-Block[®] - 17 cm, U=0,15 W/m²K

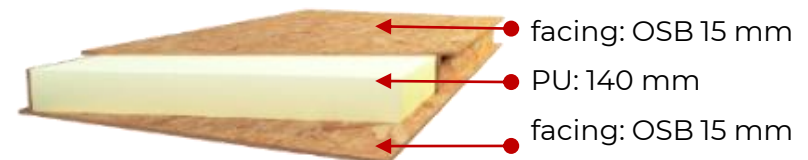

It is possible to produce H-Block[®] panels of non-standard thickness on special order.



Types of H-BLOCK[®] panels

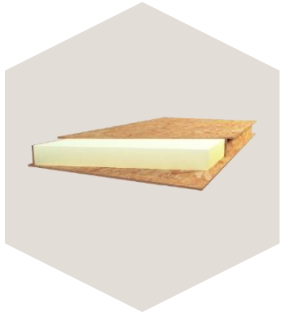

H-Block[®]

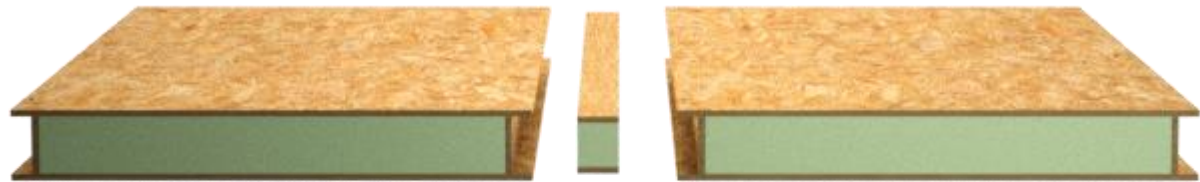

Insulated LHB joint



Types of H-BLOCK[®] panels

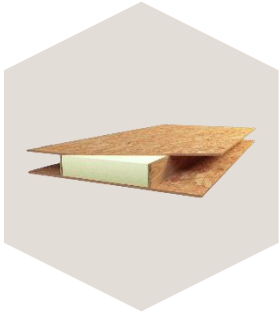

H-Block_{plus}[®]



Insulated LHB_{plus} joint



Types of H-BLOCK[®] panels

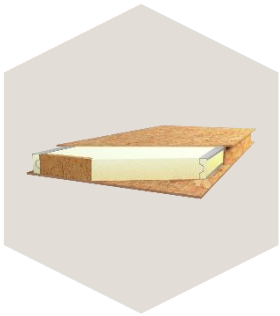

H-Block[®]*sigma*

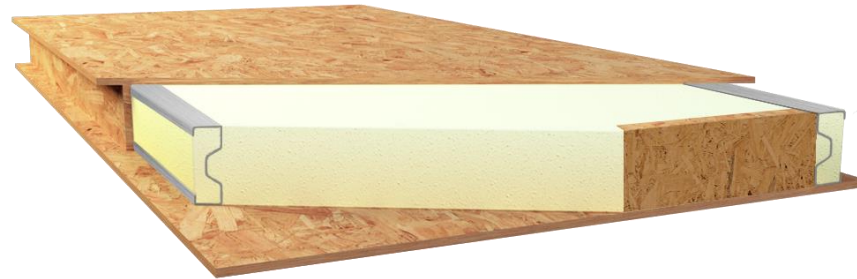

Connection of panels
with insulated LHB joint



Higher mechanical strength, which is required in the construction of inter-storey ceilings, flat roofs and pitched roofs.



Application of H-BLOCK[®], H-BLOCK_{plus}[®] and H-BLOCK_{sigma}[®] panels



Floors and inter-storey ceilings



Application of H-BLOCK[®] panels

external and internal load-bearing walls



Application of H-BLOCK[®], H-BLOCK_{plus}[®] and H-BLOCK_{sigma}[®] panels



roofs



Types of Thermont[®] panels

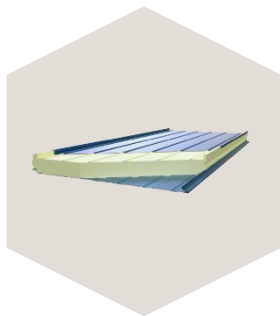

Thermont[®]

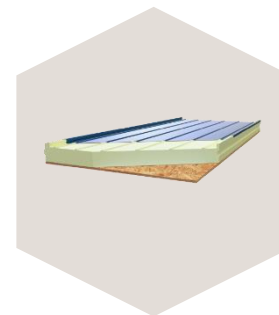

Thermont_{plus}[®]

	Thermont [®]	Thermont _{plus} [®]
Width	1,10 m	
Length	up to 12,5 m	
External facing	galvanized steel sheet, th. 0,5 mm	
Internal facing	galvanized steel sheet, th. 0,5 mm	OSB 3 th. 15 mm
Piping	NO	
Functions:	<ul style="list-style-type: none"> • cladding on its own or complementary to Thexpan[®]/Thexpan_{plus}[®] panels • insulating function, • structural function. 	

Additionally in the **Thermont_{plus}[®]** variant:

- no thermal bridges (OSB board from the inside of the roof),
- no need to cut the inner sheet during assembly.



What is Thexpan[®]

Thexpan[®] is:

- a thermodynamic sandwich panel dedicated to cover the roofs of energy-saving and passive buildings,
- a unique combination of sandwich panel and heat exchanger that leads to reduction of both capital and operating costs.
- the only roof panel in the world that can be used as a source of power for heat pumps.

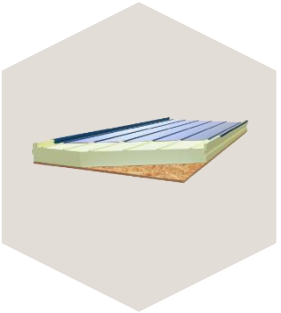
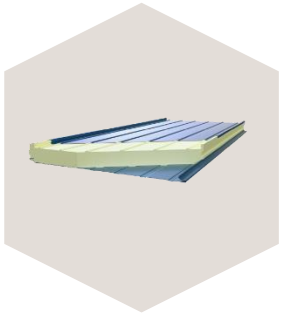

Application of Thermont[®], Thexpan[®],
Thermont_{plus}[®] and Thexpan_{plus}[®] panels



Why SOLCRAFT[®] ?

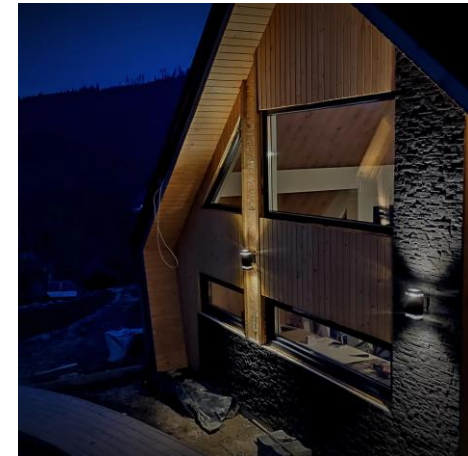

Why SOLCRAFT® ?

Insulation

SOLCRAFT® panels have exceptional thermal properties due to the use of a closed-cell PU foam core. Closed-cell polyurethane foam is an insulation material with the highest thermal resistance among building insulation materials available on an industrial scale.

The thickness of the partition needed to obtain the heat coefficient $U=0.20 \text{ W}/(\text{m}^2\text{K})$

PU thickness	100 mm	140 mm	200 mm
Heat transfer coefficient of the panel (declared) – $U \text{ [W}/\text{m}^2\text{K}]$	$U=0,21 \text{ [W}/\text{m}^2\text{K}]$	$U=0,15 \text{ [W}/\text{m}^2\text{K}]$	$U=0,10 \text{ [W}/\text{m}^2\text{K}]$

The thickness of the partition needed to obtain the heat coefficient $U=0.20 \text{ W}/(\text{m}^2\text{K})$

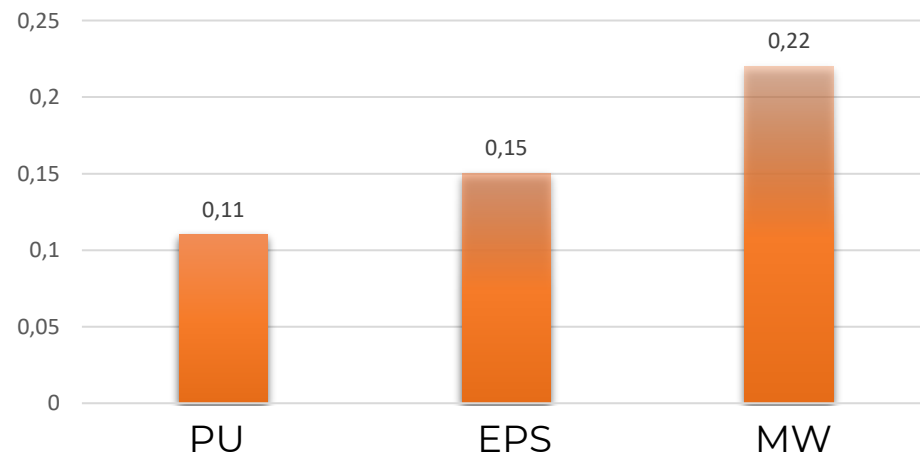

Why SOLCRAFT® ?

Air tightness

H-Block® panels are joined using a LHB joint filled with polyurethane foam. Thanks to this, the thermal bridge effect is reduced, creating a well-insulated, uniform wall or roof surface. Each connection is filled with low-pressure polyurethane foam assembly, which ensures perfect tightness of the connection.

Thexpan® and Thermont® panels are connected by means of the only labyrinth lock on the market, which in itself ensures perfect tightness. In buildings with special requirements (e.g. passive), the connection is glued with sealing tape and then covered with a roof clip.

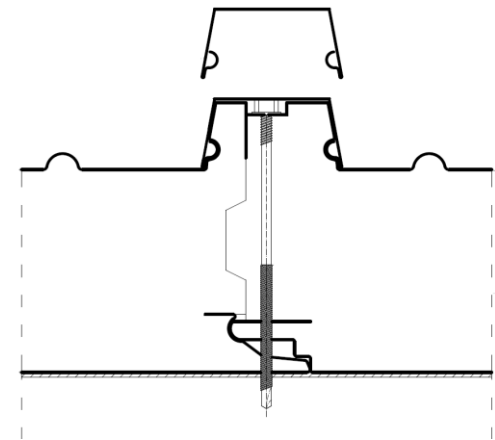
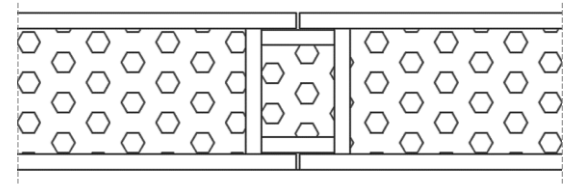

Why SOLCRAFT® ?

Bearing capacity

In the case of:

- H-Block® panels - integration of PU with the I-beam structure of OSB boards ensures their unique mechanical properties. This allows the construction of self-supporting roofs or with reduced roof trusses and ensures the load-bearing capacity of external walls up to 4 storeys;
- Thexpan®, Thermont® and Frigothex® panels - the embossing of steel sheet dedicated to the heat exchanger installation provide additional rigidity and increase load-bearing capacity. Panels are also reinforced by the humps on the panel joint, additionally closed with a snap roof clip.
- H-Block_{sigma}® - the use of "sigma" steel profiles increased the mechanical strength of the panels, thanks to which a greater span of the elements can be obtained, without the need to support them.

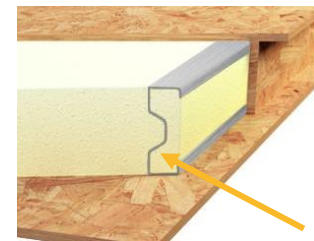
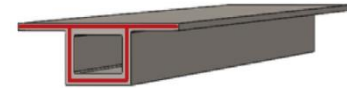

sigma profile



Why SOLCRAFT® ?

Durability and resistance

Unlike **expanded polystyrene** (polystyrene), polyurethane foam is resistant to the most common chemical reagents, insects, rodents and high temperatures on roofs.

Unlike **mineral wool**, closed-cell polyurethane foam is completely resistant to moisture, does not degrade in contact with water vapor, does not lose heat resistance and is not a substrate for the development of microorganisms. It ensures complete air and vapor tightness of filled elements.

Closed-cell polyurethane is resistant to:

- most organic solvents,
- acids and bases,
- Insects and rodents,
- fungi and molds
- water
- high temperature on the roof.

Closed-cel polyurethane:

- does not change its insulating properties over time,
- does not age,
- does not absorb moisture.



Why SOLCRAFT® ?

Design flexibility

Buildings in SOLCRAFT systems are designed using the highest quality 3D CAD / CAM software (Dietrich's). Thanks to it, it is possible to "panelize" almost every object and optimize the use of boards so as to minimize the amount of waste on the construction site, and thus reduce costs,

The H-Block® system also provides total freedom in terms of roofing and façade finishing,

H-Block® as load-bearing and insulating material at the same time, provides the thickness of walls and roofs nearly twice as thin as in traditional buildings,

The PU insulation layer is almost twice smaller than when using mineral wool or foamed polystyrene. This allows for additional usable space and higher rooms in the attic.

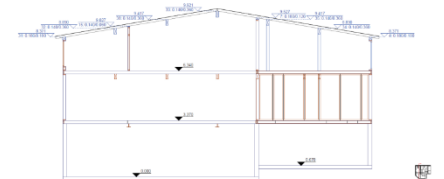
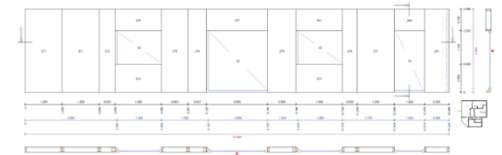

Why SOLCRAFT[®] ?

Building process

- The fact that SOLCRAFT[®] panels are manufactured in the production hall provides them with high quality and enables construction of a house regardless of the weather.
- A small number of elements (as opposed to traditional technology, for example) produced individually "to measure" for each project, ensures quick assembly and limits the possibility of assembly errors.
- Thanks to the small thickness and weight of the panels, the structure of the building made in SOLCRAFT[®] systems is lighter, which significantly reduces investment costs. This is due to e.g. smaller: depth and size of foundations, depth of eaves, thickness of floor beams, rafters and columns; the length of the fasteners and the structure of the building.
- Minimal tools are required for construction of buildings in SOLCRAFT[®] technologies. The lightness of the panels eliminates the need for heavy machinery.



Why SOLCRAFT® ?

Quick installation = quick return on investment

- Ability to quickly move into the facility,
- Shorter rental period,
- Possibility of faster sale of the current house / apartment,
- Faster return on invested capital,
- Improvement of financial liquidity,
- No need for long-term supervision by the investor at the construction site,
- The possibility of earning faster,
- Greater creditworthiness - the operating costs of buildings are much lower than in traditional buildings, and thus they "strain" the household budget less, thus increasing creditworthiness.



Patents and Awards

As SOLCRAFT®, we possess number of US and EU patents for our solutions. We are the laureates and holders of many certificates and prizes, including:

- Double winner of GreenEvo - Green Technology Accelerator – the project organized by the Ministry of the Environment,
- Ambassador of the Polish Institute of Passive Construction and Renewable Energy
- A member of the world's largest association of SIP panel manufacturers - Structural Insulated Panel Association (SIPA)
- The Silver Laurel of Innovation 2016 for the Thexpan® system awarded by the Supreme Technical Organization NOT
- Consumer's Golden Laurel 2021 in the category of ecological strategies in business/industry

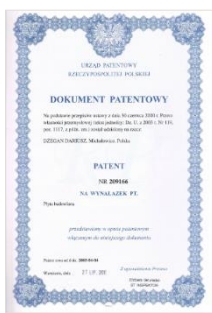

Selected projects

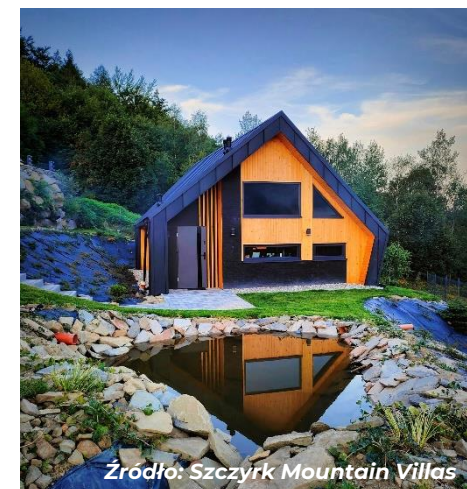

Selected projects



Want to know more?
Contact us or
A1 – Smarthomes Australia

0432 070 222



office@solcraft-systems.com
info@a1smarthomesaustralia.com.au